

Creating a Simulation of Assembly of a Selected Component in a Virtual Environment

Naqib Daneshjo¹, Albert Mareš², Peter Malega², Samuel Chlpek¹, Tomáš Bañas²

¹University of Economics in Bratislava, Faculty of Commerce, Dolnozemska cesta 1, 852 35 Bratislava 5, Slovak Republic

²Technical university of Kosice, Faculty of Mechanical Engineering, Letná 9, 042 00 Košice, Slovak Republic

Abstract – The objective of this paper is a virtual environment that uses CAD models of products and their components allows to streamline the design of production processes, including the assembly processes. The creation of such production models can be lengthy but can bring significant time and financial savings. These savings are based on the implementation of an already debugged and virtually tested solution. The article describes the creation process of a virtual assembly procedure for a turbocharger with the purpose of subsequent analyses.

Keywords – manual assembly, assembly process, Delmia, RULA, turbocharger.

1. Introduction

It's typical for the current economy that the offer significantly exceeds the demand for various categories of products. The customer thus gains unprecedented power and the statement „our customer is the king" is more valid than ever before.

DOI: 10.18421/TEM121-66

<https://doi.org/10.18421/TEM121-66>

Corresponding author: Naqib Daneshjo,
University of Economics in Bratislava, Faculty of
Commerce, Dolnozemska cesta 1, 852 35 Bratislava 5,
Slovak Republic

Email: daneshjo47@gmail.com

Received: 28 October 2022.

Revised: 01 February 2023.

Accepted: 07 February 2023.

Published: 27 February 2023.

 © 2023. Naqib Daneshjo et al; published by UIKTEN. This work is licensed under the Creative Commons Attribution-NonCommercial-NoDerivs 4.0 License.

The article is published with Open Access at <https://www.temjournal.com/>

With the increase in customer power, companies have been forced to transform their organization, culture, and processes in recent decades in such manner so they can listen more effectively to the needs of their customers [3], [6]. Especially they need to be able to satisfy these needs through their products in a flexible manner. The experience of many companies shows that this transformation is not possible without the company's focus on its processes, which must be constantly improved in terms of performance and flexibility [1].

Constant innovation and improvement in the engineering industry has also brought improvement in the field of computer-planned production and in all processes related to it. Computer-planned and controlled production is the basis of the success for several engineering companies [5], [9].

Achieving the best possible results in production planning, as well as in the production itself, can be helped by the Delmia software [2], [11]. This software allows to simulate the production process in a virtual environment even before the production premises are built. With the help of this software, we can model the exact layout of machines and tools that will be needed for production and assembly [4], [13]. We can also simulate the movements and operations that are necessary for the production itself [12].

2. Selection of a component for a virtual assembly

To create an assembly simulation, a component – a turbocharger for a passenger car - was selected. It is a device that fills the engine cylinders with air under high pressure. Since the engine is not limited by the amount of fuel injected, but by the volume of air that is delivered to the cylinders, it is possible to increase engine performance by connecting a turbocharger to the exhaust and intake system [8].

There are many types of turbochargers, various designs and sizes that provide different performance levels.

The most common classification of turbochargers is according to the volume of air they can bring into the combustion process. This depends on the size of the turbocharger and on the size of the turbine and compressor casing. Each model has its own specifications that explain its usage and limitations [7], [10]. There are many specifications according to which a turbocharger is selected. In most cases the fastest possible performance delivery of the turbocharger is looked for, so that it provides sufficient power for quick and smooth acceleration from the lowest possible revolutions.

Figure 1 shows the CAD model of the turbocharger that will be the subject of assembly. The CAD model was created in the CATIA software.

A turbocharger consists of various parts. The type and size of the turbocharger influence the number and complexity of parts it consists of. In the past, turbochargers were used exclusively to increase power and were less complex than today.

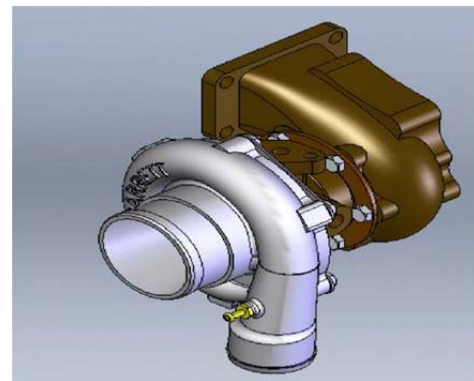

Figure 1. CAD model of a turbocharger

Nowadays turbochargers are used mainly to reduce consumption and emissions produced by the car, so they are more complex. The turbocharger consists of three main parts:

1. Suction part – the purpose of this part is to suck air into the turbocharger.
2. Bearing part - ensures lubrication and housing of the turbocharger.
3. Exhaust part – ensures the drive of the turbo with the help of exhaust gases.

The individual parts of the turbocharger that were modelled and used in the assembly simulation are shown in Figure 2.

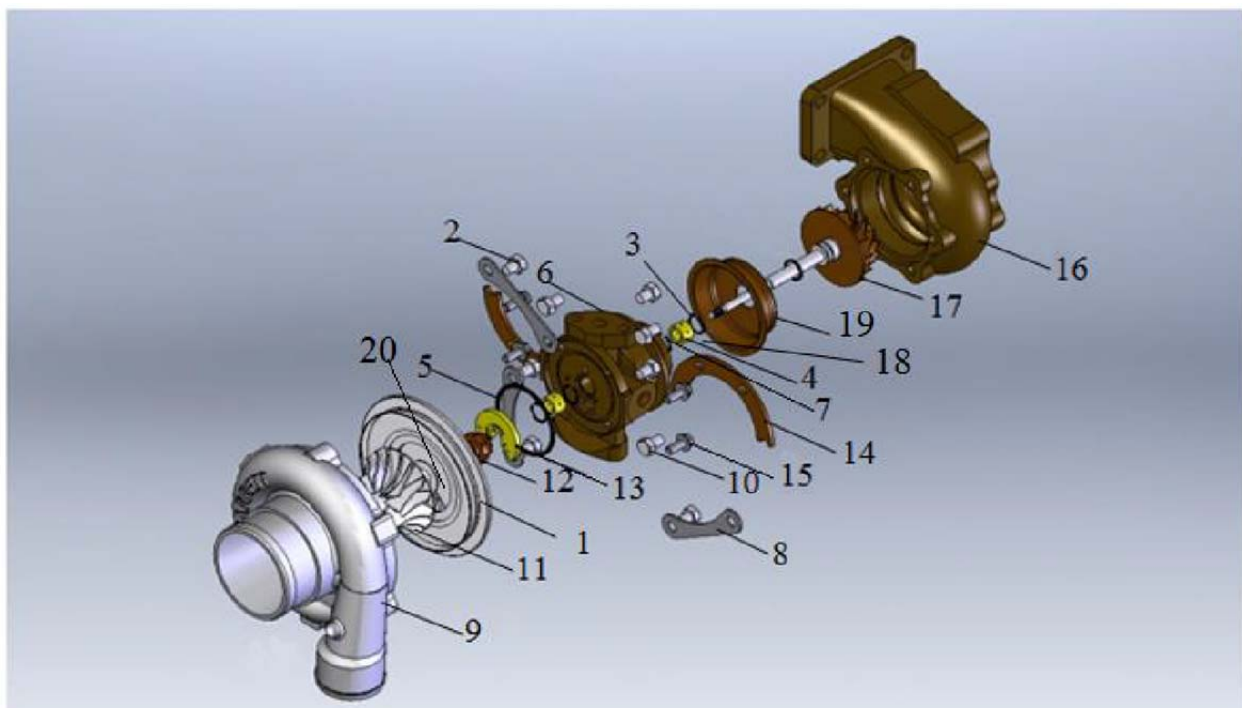
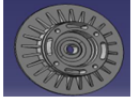









































Figure 2. Individual parts of the turbocharger

A description and comparison of CAD models of individual parts with real parts is in Table no. 1.

Table 1. Description and comparison of CAD models with real parts

No.	Name	3D model	Real part
1	Rear part		
2	Screw of rear part		
3	Circlip		
4	Bearing		
5	Seal		
6	Bearing housing / Central part		
7	Oil bearing circlip		
8	Compressor holder		
9	Compressor body		
10	Compressor body screw		
11	Compressor wheel		
12	Oil bearing		
13	Thrust bearing		
14	Turbine holder		
15	Rear part screw		
16	Turbine body		

17	Turbine wheel		
18	Turbine nut head		
19	Turbine cover		
20	Thrust ring		

Turbocharger assembly consists of several assembly operations in which individual parts are combined into assembly subgroups and partial outputs. Schematic assembly procedure of the turbocharger is shown in Figures 3, 4, 5 and 6. Abbreviations such as Assembly Subgroup (MP), Partial Output (V) and Final Product (FV) are used in the diagrams.

The assembly began with the build of the assembly subgroup 1 from the central parts, the bearing, and the circlip. V1 is composed of an oil and thrust bearing, V2 is composed of a rear part and a thrust ring. MP1, V1, V2, rear part screw and high temperature cover are assembled into MP2, which further continues to assembly (Figure 3).

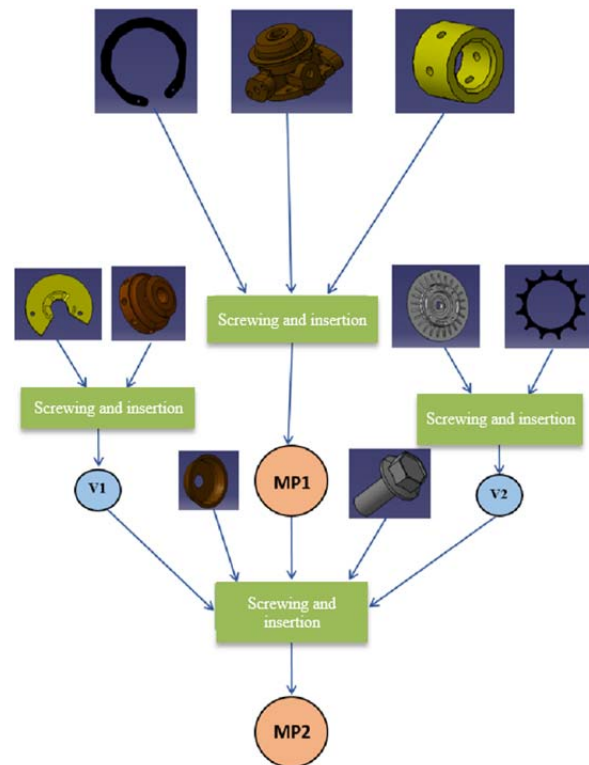

Figure 3 Assembly diagram of the central part (creation of sub-outputs V1, V2 and assembly subgroups MP1 and MP2)

To complete V3, MP2 from the previous operations is needed, together with the turbine wheel, the compressor wheel and the nut that provides insurance against disintegration (Figure 4).

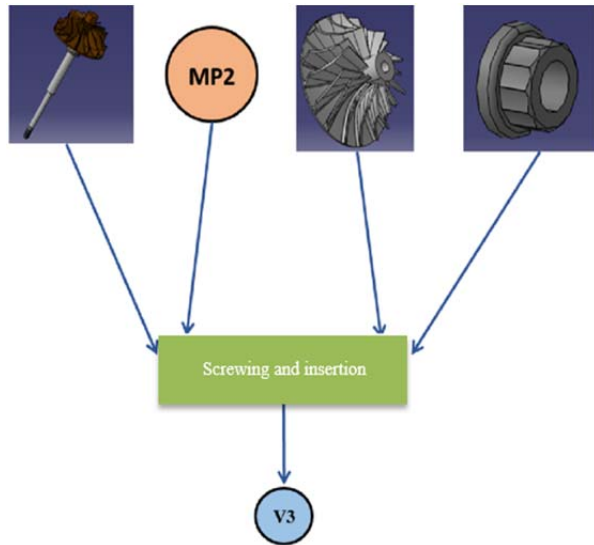

Figure 4. Assembly the partial output - V3

The assembly of the V4 output consists of the assembly of four parts, namely the V3 output from the previous operation and the turbine body holder, the compressor body screw, and the turbine body (Figure 5). These operations are carried out by screwing and insertion.

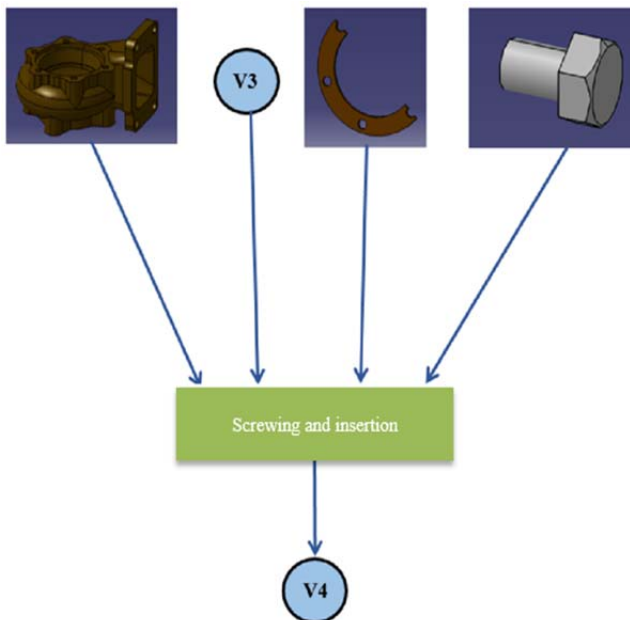

Figure 5. Assembly of the V4 partial output

The assembly of the final product (FV) is made of 4 parts, namely the V4 partial output and the compressor body holder, the compressor body screw and finally the compressor body itself (Figure 6).

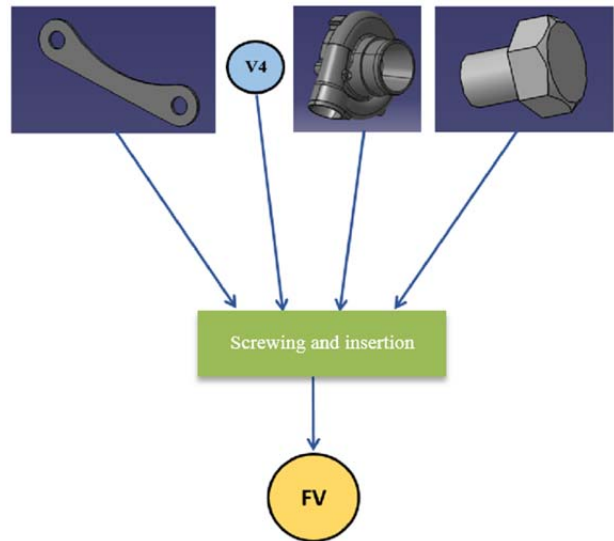

Figure 6. Assembly the final product (FV)

3. The procedure and process of creating an assembly simulation in a virtual environment

The virtual assembly of the turbocharger was carried out in the Delmia software. The entire room, the worktable, the shelves, the light, and the pallets were modelled according to the real room, so that the virtual assembly corresponded as closely as possible to the assembly in real conditions and its results were relevant. The worktable and shelves can be adapted to the needs of the given production and the number of boxes used can also be adjusted as needed. On the left side is a sliding shelf with wheels that can be moved around the room as needed. It has three shelves on which there are two boxes of larger dimensions each, for the largest parts used. Above the table are two shelves that contain medium-sized and larger boxes. The height of the shelves can be adjusted by moving the shelves up or down. The quantity and type of boxes can also be changed depending on which parts are used in a particular assembly. The tabletop has sufficient dimensions to accommodate some of the boxes required for assembly. The smallest boxes are placed on the tabletop and are arranged in a semicircle for a better reach of the parts and for their handling (Figure 7).

The above-mentioned boxes, which are of three different sizes, are used to store parts. The boxes are not only different in size, but also in colour. The distribution of the boxes was made with regards to the size and weight of the parts and according to the individual operations so that the worker could easily handle them. The smallest parts and the parts that will be used first are placed in boxes directly on the worktable, considering the hand used for their assembly.

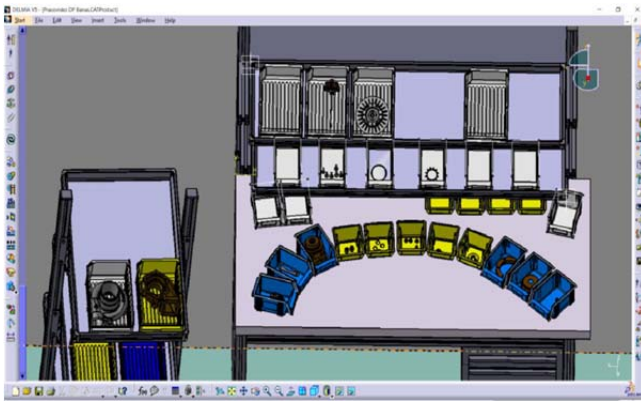

Figure 7. Workplace model with boxes for individual components

After creating the workplace model with components, a worker model - mannequin - was inserted into the workplace. The latter was inserted using the Human Builder module (Figure 8).

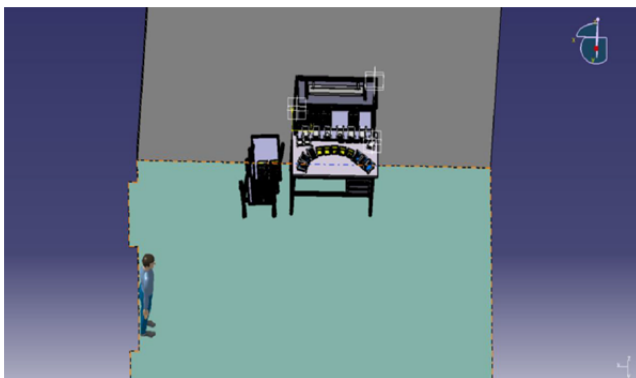

Figure 8. Inserting a worker (mannequin) into the model

The arrival of the worker at the workplace is also part of the simulation, so it was necessary to define the path that the worker will take from the door to the desk. The "Walk" function was used to define the walk from the door to the desk. Defining the path of the worker is shown in Figure 9.

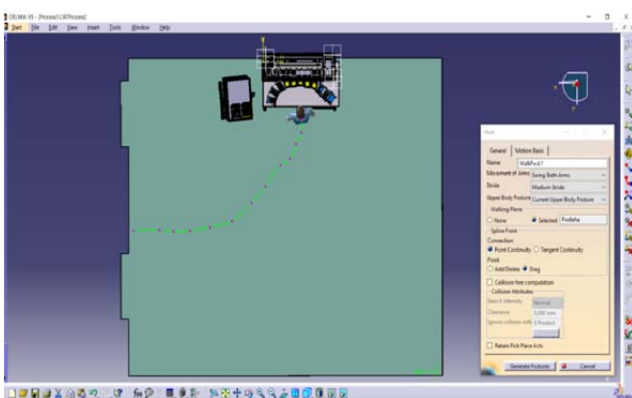

Figure 9. Defining the path to the worktable

After arriving at the workplace, the actual assembly of the selected part begins. Definition of the worker's movements during assembly was performed using the "Forward Kinematics" function. Using this function, the left hand was positioned to remove the central part of the turbocharger from the box. Subsequently, the "Create Move To Posture" function was used to save the given position as a movement in the simulation. After reaching the required position with the left hand, predefined functions were used, specifically grasping, on larger parts. With this feature, the thumbs of the hand are automatically positioned to grasp the object. We used the "Reach Point" function to place the left hand more precisely on the central part. After reaching the central part, lifting the part was used, which means creating a bond between the left hand and the central part. Subsequently, it was possible to move the hand and the central part at the same time. The "Place part" function was used to place the given part on the table. This function has been supplemented with a "Snap" function to place the part in a precise location with a precise orientation (Figure 10).

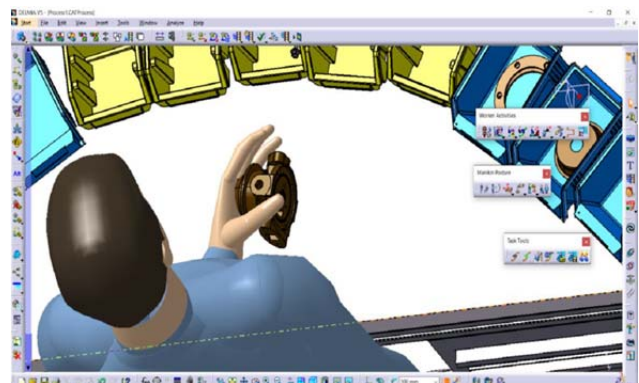

Figure 10. Positioning the central part

The central part was placed on the worktable on the left side. This position was chosen mainly so that the subsequent installation of the radial bearings could take place without another unnecessary turning operation. In this position, it was possible to install both bearings in the upper and lower sides without the need for further handling of the body (Figure 11).

The already mentioned "Inverse Kinematics" function was used to simulate the bearing insertion, but in this case, it was more difficult as the parts were smaller. The "Snap" function was used to insert the bearings. The usefulness of this function lies in the fact that it is possible to insert the part in a place that you choose or define.

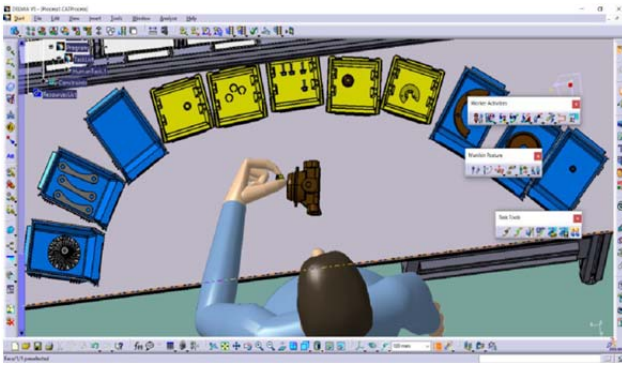

Figure 11. Inserting the bearings into the central part

The next step was to turn the central part together with the inserted parts on the upper side and install the oil bearing. The oil bearing is mounted together with the thrust bearing. First, it is necessary to connect both parts and then insert them into the hole on the underside of the turbocharger.

After inserting the oil pump into the central part, the assembly of the rear part and the retaining ring followed (Figure 12).

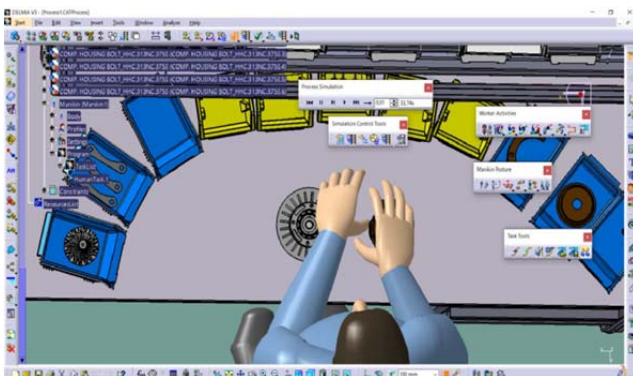

Figure 12. Placing the central part on the back

The next step is to put the heat shield on the top part. It is fixed using the compressor blades and the turbine. After placing the heat shield, the middle part is almost complete.

The turbine blades and compressor blades need to be inserted to complete the middle section. After rotating the central part, it is necessary to hold it with the right hand and then with the left hand grasp and move the turbine wheel, which will be inserted into the central part afterwards.

After inserting the turbine wheel, the next operation was to insert the compressor wheel, which is secured with a nut. After securing with a nut, the middle section is completed. The process continues with the insertion of the middle section into the compressor and turbine casing (Figure 13).

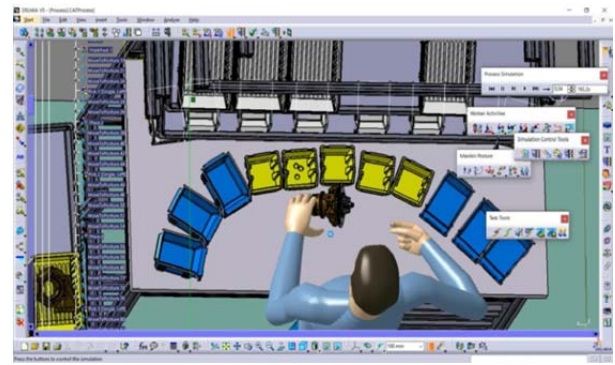

Figure 13. Relocating the complete middle section

After folding and moving the assembled middle section, it is necessary to move the turbine housing from the side sliding rack to the assembly table. After moving the turbine housing to the worktable, the middle part is inserted into the turbine housing.

Following the placement of the middle section in the turbine housing, the compressor housing is placed on top of the middle section. The compressor housing is also on the side sliding rack. These parts are placed there mainly due to their size. They are too large to be placed in smaller pallets and it would be difficult to lift them from the top shelf above the table, so they are placed on the side sliding rack.

After placing the turbine body on the middle part, it is still necessary to place the finished product on the table or in the pallet intended for finished products, from where they are taken to the warehouse (Figure 14).

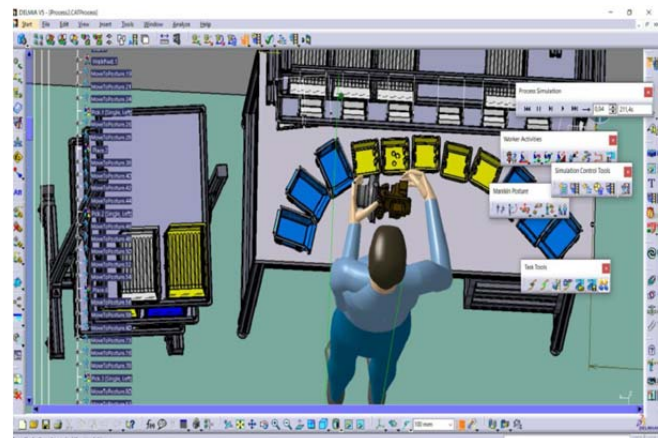

Figure 14. Removing the finished product from the table

From the given assembly simulation, it is clear that in the Delmia software the assembly can be carried out in the same way as it is carried out in real conditions. All parts were used to assemble the turbocharger like in the case of a real component.

Creating a video showing the assembly process itself is not complicated, as there is a recording module in Delmia with this function. The most time-consuming activity is positioning the worker in the exact positions, fixing the parts, repositioning, assembly, and subsequent creation of movements. The fact that the program does not have automatic protection against the intrusion of one object into another or protection against the intrusion of the worker's hands into solid bodies generates the greatest effort in creating the simulation. Although Delmia reports the penetration of objects into other objects (Collision Detector) during the simulation, this function only alerts us, but cannot automatically prevent it by avoiding the component. Because of these small flaws, creating a simulation is sometimes a lengthy process. From a financial point of view these shortcomings are negligible for users, because the simulation created in Delmia significantly reduces the time needed to make assembly more efficient.

4. Analysis of the assembly process

After creating a simulation of the assembly procedure, it is possible to perform various types of analysis in the Delmia software, including ergonomic ones. Considering that the present case is a manual assembly, ergonomic analyses are very important.

They allow predicting the worker's load and thus prevent their overloading. They also allow the elimination of inappropriate movements and positions. For illustration, the use of RULA (Rapid Upper Limbs Analysis) analysis is shown. This method focuses on assessing the load on the upper body and arms. It assesses the difficulties associated with the movement of the hands, trunk, and head. It evaluates them and then shows with the help of a colour scale whether these movements are good and acceptable or not. During the assessment, a scoring scale is used, which evaluates individual parts of the body, and based on the load on individual parts of the body, a total score is calculated, which expresses the total load of the worker (Table 2).

These intermediate scores, represented by a number and a colour, are used to calculate the final RULA score. The following table indicates the score range for each segment as well as the associated colour.

Table 2. The score range for each segment as well as the associated colour

Segment	Score Range	Color associated to the score					
		1	2	3	4	5	6
Upper arm	1 to 6	Green	Green	Yellow	Yellow	Red	Red
Forearm	1 to 3	Green	Yellow	Red	Grey	Grey	Grey
Wrist	1 to 4	Green	Yellow	Orange	Red	Red	Red
Wrist twist	1 to 2	Green	Red	Grey	Grey	Grey	Grey
Neck	1 to 6	Green	Green	Yellow	Yellow	Red	Red
Trunk	1 to 6	Green	Green	Yellow	Yellow	Red	Red

During this analysis it is possible to set whether the right or left part of the body will be analysed. Accordingly, a part of the mannequin will then be coloured using the colour scale from the RULA analysis and will change depending on the load put on the worker during the given movements. In this way, it is possible to dynamically monitor changes in the worker's workload while performing a work task.

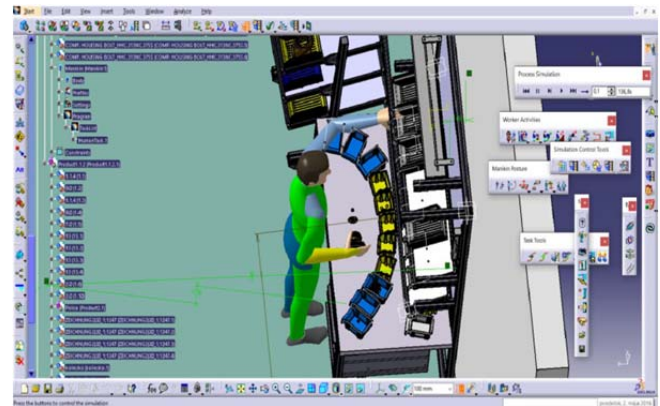

Figure 15. Rula analysis of the right part of the worker

Figure 15 shows a mannequin with colouring according to the results of the RULA analysis. We see different loads acting on the worker. For the forearm, a point evaluation is used on a scale from 1 to 3, and the yellow colour means 2 points, which represents an acceptable load. In turn, a scale from 1 to 4 is used to assess the load on the wrist. The yellow colour in this case also means 2 points i.e., still acceptable load. The result from the other parts of the body is 1 point, which is the best rating i.e., the parts of the body coloured in green are fine. This job position does not show major problems and is therefore acceptable.

In this way, the entire assembly process was gradually analysed and, when problematic areas were found, adjustments to the assembly process were proposed. These were then re-modelled and simulated to verify whether the proposed change brought the expected improvement of the assembly process.

5. Conclusion

Creating a digital model of a real or intended workplace can be time-consuming in some cases. If used correctly, it will significantly improve the final design that will be implemented. Improvements achieved by simulating all activities as they are or will be can significantly reduce costs associated with additional adjustments to workplaces which will be noted only when the workplace is actually used. The potential costs would be in the form of low productivity, low quality, or health problems of workers. The application of a digital simulation helped to find and eliminate problem areas of the workplace, even before its real deployment, which resulted in significant savings.

Acknowledgements:

This work has been supported by the Scientific Grant Agency of the Ministry of Education of the Slovak Republic (KEGA 002TUKE-4/2020, KEGA 029EU-4/2022 and Project KEGA 030EU- 4/2022).

References

- [1] Al-Ahmari, A. M., Abidi, M. H., Ahmad, A., & Darmoul, S. (2016). Development of a virtual manufacturing assembly simulation system. *Advances in Mechanical Engineering*, 8(3), 1687814016639824.
- [2] Brough, J. E., Schwartz, M., Gupta, S. K., Anand, D. K., Kavetsky, R., & Pettersen, R. (2007). Towards the development of a virtual environment-based training system for mechanical assembly operations. *Virtual reality*, 11(4), 189-206.
- [3] Connacher, H. I., Jayaram, S., & Lyons, K. (1995, September). Virtual assembly design environment. In *International Design Engineering Technical Conferences and Computers and Information in Engineering Conference*, 17018, 875-885. American Society of Mechanical Engineers.
- [4] Craciun, E. G., Grisoni, L., Pentiu, S. G., & Rusu, I. (2013). Novel interface for simulation of assembly operations in virtual environments. *Advances in Electrical and Computer Engineering*, 13(1), 47-53.
- [5] Daneshjo, N. (2020). Methodological Procedures Applied to the Manufacturing Systems Design. *Advances in Science and Technology. Research Journal*, 14(4).
- [6] Dimitropoulos, N., Toghias, T., Michalos, G., & Makris, S. (2020). Framework enabling the design of Virtual Environments used for simulation of assembly operations. *Procedia Manufacturing*, 51, 571-576.
- [7] Holm, R., Stauder, E., Wagner, R., Priglinger, M., & Volkert, J. (2002, March). A combined immersive and desktop authoring tool for virtual environments. In *Proceedings IEEE Virtual Reality 2002*, 93-100. IEEE.
- [8] Kováč, J., Rudy, V., Mareš, A., Kováč, J., & Malega, P. (2012). Integrated designing of production systems on the physical and virtual modelling base. *Acta Mechanica Slovaca*, 16(1), 30-40.
- [9] Muthaiyan, A., & Cecil, J. (2008). A virtual environment for satellite assembly. *Computer-Aided Design and Applications*, 5(1-4), 526-538.
- [10] Murray, N., & Fernando, T. (2004). An immersive assembly and maintenance simulation environment. In *Eighth IEEE International Symposium on Distributed Simulation and Real-Time Applications*, 159-166. IEEE.
- [11] Taylor, F., Jayaram, S., Jayaram, U., & Mitsui, T. (2000, September). Functionality to facilitate assembly of heavy machines in a virtual environment. In *International Design Engineering Technical Conferences and Computers and Information in Engineering Conference*, 35111, 737-745. American Society of Mechanical Engineers.
- [12] Waly, A. F., & Thabet, W. Y. (2003). A virtual construction environment for preconstruction planning. *Automation in construction*, 12(2), 139-154.
- [13] Zhu, H., Wu, D., & Fan, X. (2010). Assembly semantics modeling for assembling process planning in virtual environment. *Assembly Automation*, 30(3), 257-267.